

Article number: 0105075

Description: Retaining ring AV 58

Note: Fitted with ZGA pliers

Measures

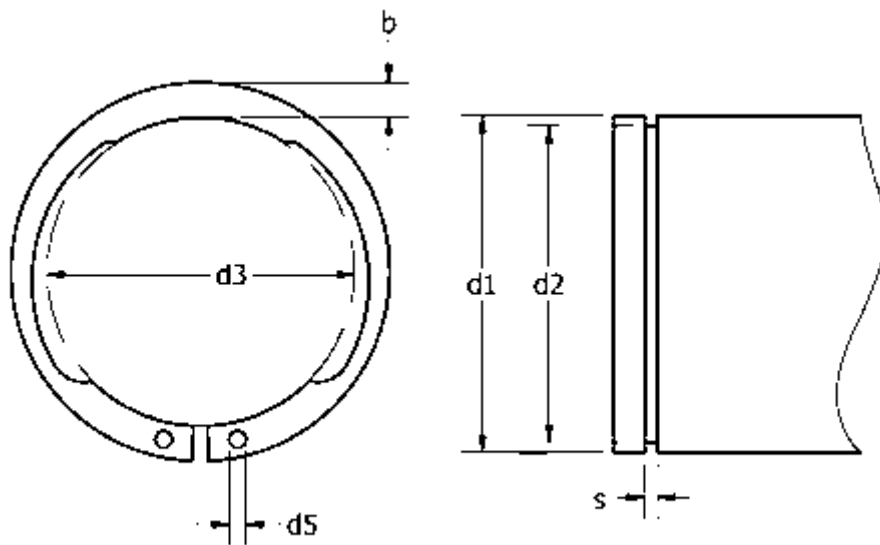

AN mm ²	= 133.0	FRg kN	= 9.2	t	= 1.50
b	= 5.8	FR kN	= 56.0	tol	= -0.07
d1	= 58	g	= 2.5	tol	= -0.30
d2	= 55.0	K kN-mm	= 100.0	tol	= +0,46-1,10
d3	= 53.80	m min	= 2.15	tol	= 0.2
d5 min	= 2.5	n abl x 1000	= 8	Tong	= ZGA-3
Description	= AV 58	s	= 2.00	Weight kg/1000	= 13.00
FN kN	= 22.20	Side power N at I2	= 4.5		